



GNSS TRACKER VEGA MT-5

User Manual



REVISION NUMBER	FIRMWARE VERSION
05	0.10b rc41.8

CONTENTS

INTRODUCTION	3
1 DESCRIPTION AND OPERATION	4
Device description	4
Functionality	4
Marking	5
2 SPECIFICATION.....	6
3 OPERATION BEGINNING	7
Device appearance	7
Contacts description	8
Device indication	9
SIM installing	10
Mounting recommendations	12
4 EXTERNAL EQUIPMENT CONNECTION.....	14
Dallas temperature sensors	14
Authorized Dallas keys	15
Switching inputs CAN/RS-485	16
Fuel level sensors	16
Extension unit	17
Actuators	17
Inputs	19
BLE-sensors	20
5 COMMUNICATION PROTOCOLS.....	21
6 MANAGING USING SMS-COMMANDS	22
7 STORAGE AND TRANSPORTATION REQUIREMENTS.....	26
8 CONTENT OF THE PACKAGE.....	27
9 WARRANTY	28

INTRODUCTION

This manual is designated for Vega MT-5 series GNSS tracker (hereinafter – the device) manufactured by Vega-Absolute OOO and provides information on powering and activation procedure, control commands and functions of the device.

This manual is targeted at specialists which familiar with installation and repairing procedures rules for motor transport and had holding of professional knowledges in the field of electronic and electrical equipment of different vehicles.



The device shall be installed and adjusted by qualified specialists to ensure proper operation of the device

For successful using of the device, you should learn monitoring system principle of operation in complex and understand the function of every its part.

Vega-Absolute OOO reserves the right to make changes to the manual related to the improvement of equipment and software, as well as to eliminate typos and inaccuracies, without prior notice.

1 DESCRIPTION AND OPERATION

DEVICE DESCRIPTION

Vega MT-5 device is designed for monitoring of vehicles by the using of GLONASS/GPS positioning systems including the determination of vehicle placement, speed, and motion direction as well as for transmitting of collected data through GSM.

Vega MT-5 uses the processor with a supporting up to three CAN-buses that allows to get a full information about vehicle.

The vehicle route is recorded as individual points in time (track). Along with the track, information is recorded coming into the device from internal and external sensors, as well as from an additional equipment. Non-volatile memory allows to store information about events and statuses of the device in the absence of power supply. Support of several servers allows to send information about vehicle status on the four servers simultaneously.

You can configure the device by SMS commands or through the “Configurator” application while the device connected with USB or by the air with TCP connection. Application also allows update a firmware and carry out the finest tuning such as operation scenarios for external equipment or CAN bus, features of fixing, recording, and transmitting of packets and many other. You can download application on the site in “Software” section and there is a Manual for work with “Configurator”. [Go to the program page.](#)

FUNCTIONALITY

Vega MT-5 provides the following functionality:

- ◉ Wialon IPS, Wialon Combine, VEGA protocols supporting
- ◉ Simultaneous operation with four servers through any of supported protocol
- ◉ Device activity can be programming by the “Scenarios” function
- ◉ Configuration through GPRS, USB
- ◉ Firmware updating through GPRS, USB
- ◉ Remotely configuring and monitoring of status through free engineer server
- ◉ Driver identification by the I-Button keys
- ◉ Temperature control at the engine compartment and the car salon with an external 1-Wire sensors
- ◉ Manage of actuators by the commands and by the events

- Built-in black box holding up to 50 000 entries
- GPS-odometer
- Trip counter
- Remotely diagnostic of the device status

MARKING

Device marked with sticker that contain the following information:

- Device name (MT-5);
- Device version (for example version 2);
- Device model (for example, CAN¹, CAN Batt etc.);
- Power supply nominal;
- IMEI – individual number is used as device ID – is placed on sticker as number and QR-code;
- Release Date;
- Country of origin, trademark.



Sticker located in three places – on device case, in factory certificate and on the packing box.

¹ For models with the corresponding sticker, software selection of the CAN or RS-485 interface is provided

2 SPECIFICATION

Parameter	Value			
		Batt	CAN Batt	CAN
Housing dimensions, mm	59 x 60 x 18			
Ingress protection rating	IP53			
External power, V	9...36			
Consumption current, mA	up to 5			
- in sleep mode	40...300			
- in active mode				
Operating temperatures, °C	– 40...+85			
Built-in battery	no	yes		no
Interfaces	RS-485		CAN or RS-485 software interface selection	
Multifunctional inputs	1			
Digital output	1			
1-Wire	1			
Ignition control input	1			
Built-in accelerometer	Yes			
GSM and GLONASS/GPS antenna	Built-in			
GSM/GPRS and GNSS module	SIM868E GSM: 850/900/1800/1900 MHz GPRS class 12 85.6 Kbit/sec GNSS: GLONASS/GPS/Galileo/QZSS Sensibility: -166dBm			
Bluetooth	BT3.0 + BLE			
SIM	2 SIM cards			
USB	micro-USB, type B			
Built-in black box	up to 50 000 entries			

3 OPERATION BEGINNING

DEVICE APPEARANCE

Vega MT-5 is represented in black plastic case which has four screws and mounting eyelets. On the case there are LED indicators signed by pictograms, wire connector and USB. Depend on device version there might be connectors for external antennas GSM and GNSS.

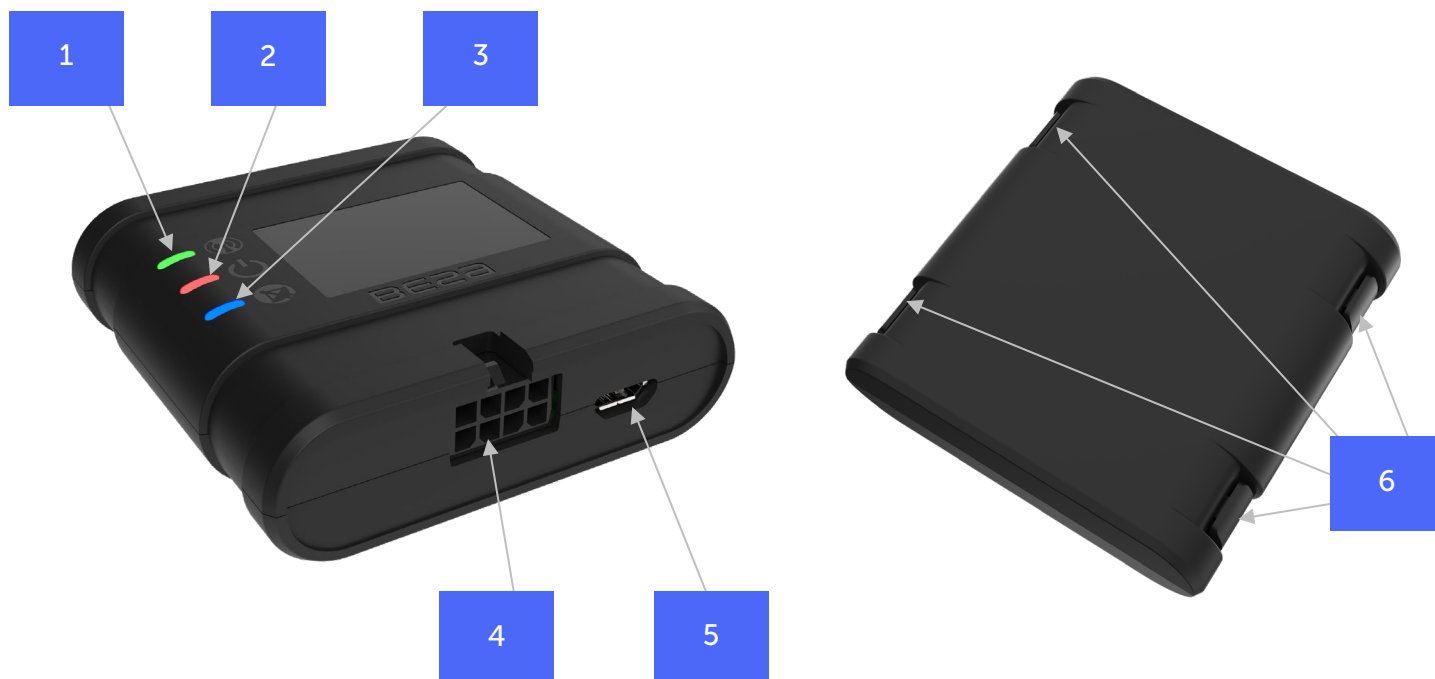

1 – LED indicator of GSM connection (green)

4 – wire connector

2 – LED indicator of power (red)

5 –USB connector







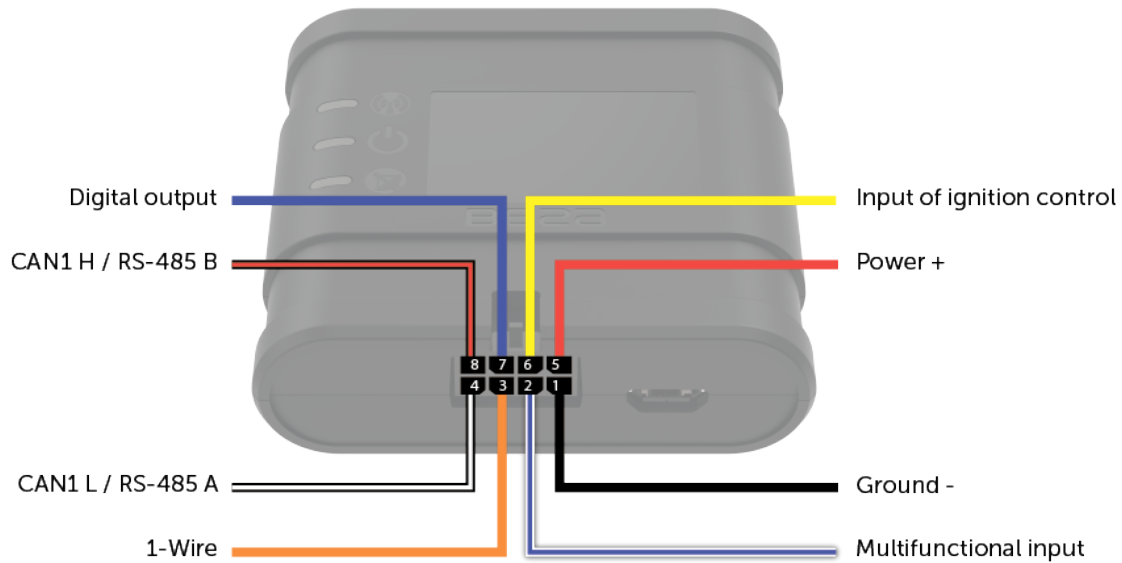

3 – LED indicator of GNSS module (blue)

6 – mounting eyelets

SIM slots are placed on the PCB inside the case (see part [«SIM installing»](#)).

CONTACTS DESCRIPTION









Contact	Wire color		Description
1	Black		Ground -
2	White + dark blue		Multifunctional input
3	Orange		1-Wire
4	Black + white		CAN1 Low ² / RS-485 A
5	Red		Power +
6	Yellow		Input of ignition control
7	Dark blue		Digital output
8	Black + red		CAN1 High ³ / RS-485 B

² Software [selection of CAN or RS-485](#) interface for models marked "CAN" in the [sticker](#)

³ Software [selection of CAN or RS-485](#) interface for models marked "CAN" in the [sticker](#)

DEVICE INDICATION

The device has three LED indicators. Blue indicator shows the navigation receiver status. Red indicator shows the presence of an external power. Green indicator shows GSM-connection status.

LED signal		Meaning
	Blue glowing	Navigation receiver in the mode of sputnik tracking. Location determined.
	Blue flashing one per second	Location determination in progress.
	Red glowing	External power supplying on.
	Red flashing	External power supplying off.
	Green not glowing	GSM-signal absent.
	Green glowing	The device is in range of a GSM network.
	Green flashing	GSM data exchange in progress.

SIM INSTALLING

To use the Vega MT-5 GNSS tracker, you need a nano-SIM with support of SMS and GPRS functions. There must be cash on the account. PIN protection must be disabled.

The device supports the ability to use two SIM cards. In this case, one of them will perform the reserve function, and will be used only if it is not possible to send data from the first main SIM.

The devices have their own algorithm for SIM-card switching from main to reserve and back:

- 1) The device cannot join to the network for the 5 minutes while it operates with main or reserve SIM-card;
- 2) If 16 unsuccessful attempts were made to establish a TCP connection to each server (not disabled in the settings);
- 3) If a TCP connection is established, but there is no data at the application level from the servers for the 5 minutes.

The location of the primary and secondary SIM slots is shown in the figure below, the primary slot is highlighted in red.

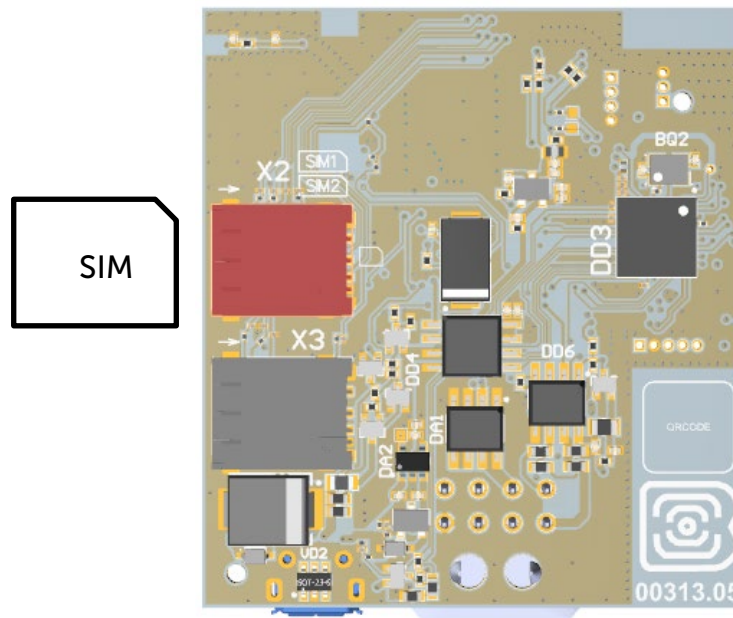



To avoid damage and malfunction, it is recommended to perform all manipulations with the PCB when it is de-energized

To install the SIM you must perform the following steps:

- 1) remove the top cover of the device and de-energize the PCB by carefully disconnecting the battery;
- 2) remove the PCB – SIM holders are located on the reverse side of the PCB;
- 3) insert the SIM into the holder;
- 4) assemble the device.

MOUNTING RECOMMENDATIONS

Before installing the block on an object, it is necessary to perform basic connection settings to be able to connect to the block remotely via TCP. Connection settings are:

- ◉ monitoring servers' settings (protocol, IP-address and port);
- ◉ network settings (SIM access point settings);
- ◉ settings for transmitting readings (information that will be transmitted to the server).

Initial configuration is carried out through USB-port with Configurator application. For this you should do the following steps:

1. Install the main SIM-card (see part ["SIM Installing"](#)).
2. Connect the device to a PC through USB-port located on the front panel.
3. Run the Configurator application on the PC, press "Connect" button and choose the connection method like "Connect through USB".
4. On the left menu choose "Settings".
5. Make connection settings.



Pay attention to the settings for connecting to the engineering server using the VEGA protocol. These parameters will be used when connecting to the device remotely through the Configurator program

6. After setting connection parameters press the "Save" button.
7. Disconnect USB-cable.
8. Try test connection through the air for checkup of the connection parameters.
9. If the connection is successfully done, then the device is ready for installing on a vehicle.

For mounting you will need:

- ◉ wires and fuse which are included in a package;
- ◉ fuse;
- ◉ wire stripper;
- ◉ laptop.

Step by step mounting is as follows:

1. De-energizing the connected equipment and the vehicle's on PCB power.
2. Connection of Ignition wire⁴ to tracker (input 6).
3. Connection of external power wires according to the scheme through a fuse.

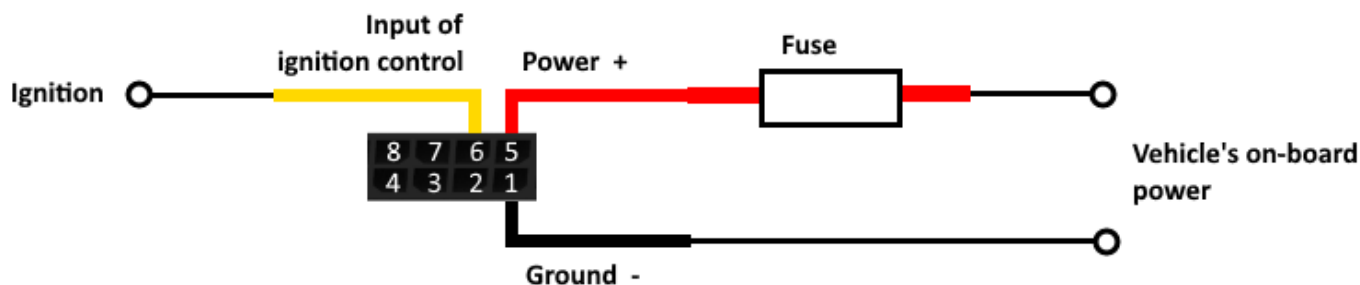

4. Power ON.
5. Connection of an external equipment, sensors, and configuration of them (see part "[External equipment connection](#)").
6. Device configuration, CAN bus operation if it is needed.
7. By the laptop you can make sure that the device is successfully configured and sends the correct data.
8. Mounting of the device with zip ties.

General recommendations for the placement of antennas boil down to two rules: avoid covering the GSM antenna with metal parts of the vehicle and, if possible, provide a line of sight to satellites (i.e., open skies).

⁴ Connecting the Ignition wire is a necessary step for the functions of monitoring and charging battery

4 EXTERNAL EQUIPMENT CONNECTION

DALLAS TEMPERATURE SENSORS

Vega MT-5 GNSS tracker allows to connect is up to ten Dallas temperature sensors through 1-Wire interface. Connection scheme is on the picture below. If connected temperature sensor has three contacts instead of two, then you should close "Power" with "Ground".

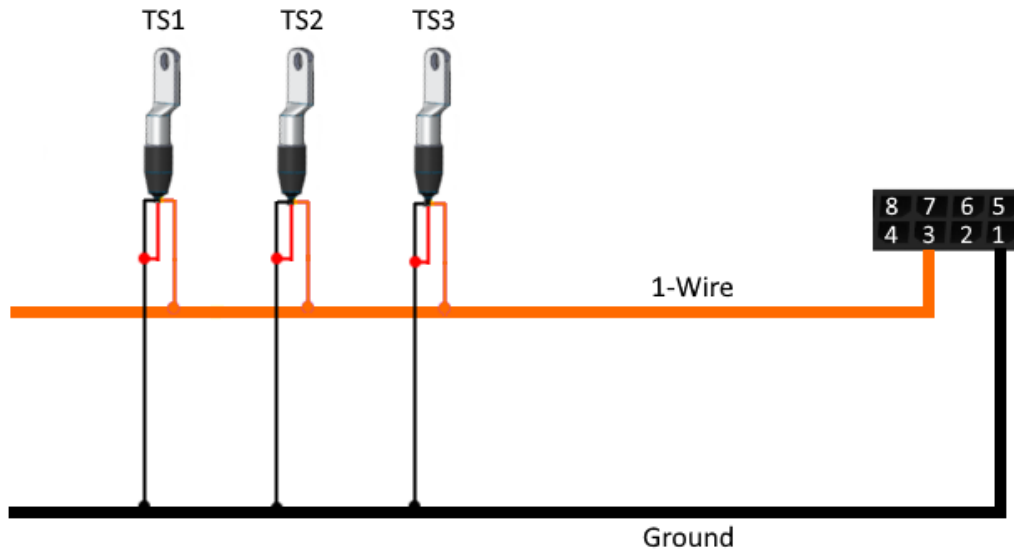

For the device to recognize the connection of a new sensor, it is necessary to connect to the device through the "Configurator" program, go to the "Settings" menu -> "Inputs/outputs" tab and select the "Dallas temperature sensors" setting item.

To distinguish sensors after connection, it is recommended to connect them one at a time. Having connected the first sensor according to the diagram above, click the "Add sensors" button. An information window will appear.

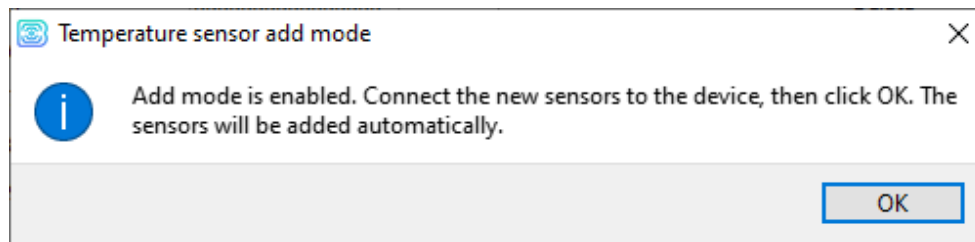

Click "OK" - the sensor number will be added to the free field. After that you can connect the next sensor in the same way.

You can also connect several sensors in turn, while the add window is open, in this case, after clicking the "OK" button, the sensors will be put into free fields in the order in which they were connected.

After connecting all temperature sensors, you must click the "Save" button to put information about sensors into device memory.

AUTHORIZED DALLAS KEYS

Vega MT-5 GNSS tracker allows you to connect an I-Button authorized key reader to a 1-Wire pin. The connection scheme is shown in the figure below. The number of authorized keys can reach ten. To add a key, you need to connect to the device through the "Configurator" program and go to the "Settings" menu -> "Security" tab.



In the "Security" tab, expand the "Authorized Dallas keys" settings item and click the "Add Dallas keys" button. A dialog box will appear.

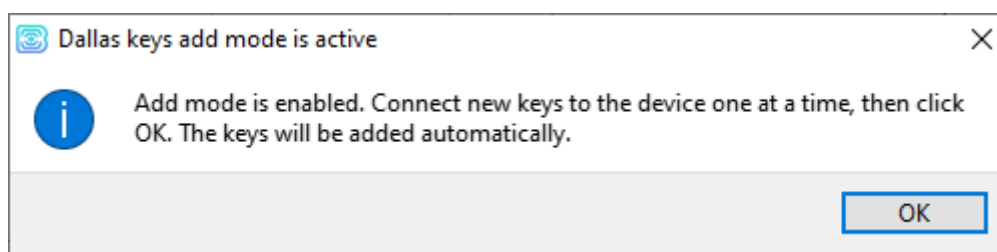

Attach the key to the reader as during authorization - the device will remember the key number - and click "OK". The key number appears in the free field. If several keys are added at the same time, it is allowed to attach them to the reader in turn, while the add window is open, and only then click "OK" - the numbers of all keys will be added to the free fields in the order in which they were applied to the reader.

Click the "Save" button to put information about keys into device memory.

SWITCHING INPUTS CAN/RS-485

GNSS tracker MT-5 with CAN-bus support by default uses [outputs 4 and 8](#) to work with CAN.

To use inputs 4 and 8 as RS-485 interface you need to connect to the device through the “Configurator” program and go to the “Settings” menu -> “Inputs/Outputs” tab.

Find the settings item “Additional interface settings” and check the box “Use CAN as RS-485”.

FUEL LEVEL SENSORS

GNSS tracker allows you to connect fuel level sensors via the RS-485 bus and operates with them using the LLS protocol.

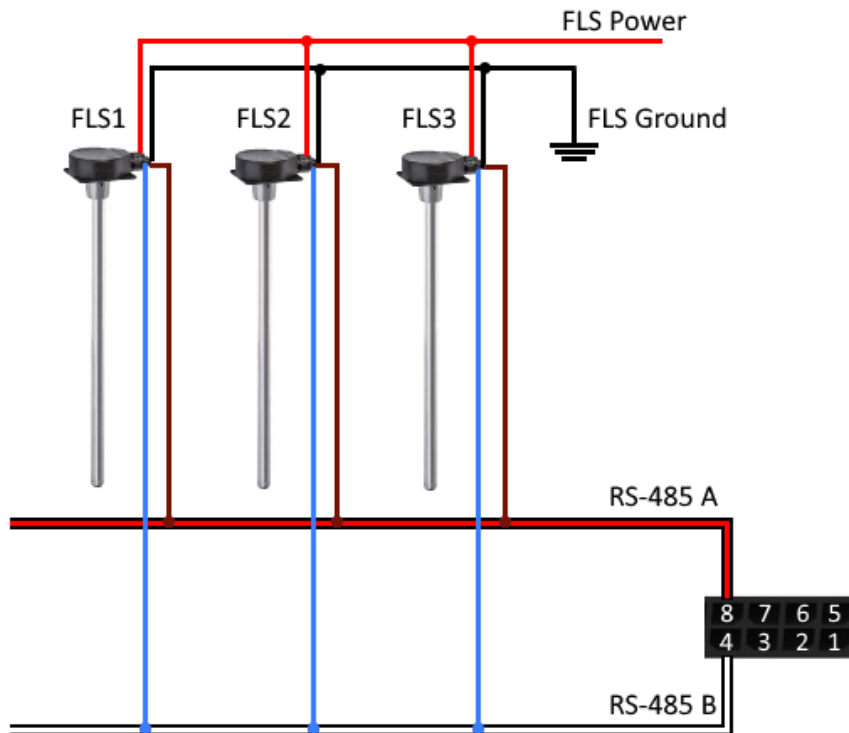

To do this, you need to connect to the device through the “Configurator” program and go to the “Settings” menu -> “Inputs/Outputs” tab. For each connected fuel level sensor, it is necessary to select “Sensor Type” - RS-485 and specify the sensor address on the bus in the “Bus Address” field. The specified address must match the address specified when the sensor programming (see instructions for the used sensor).

Up to four fuel level sensors can be connected simultaneously.

Click the “Save” button to put information about sensors into device memory.

EXTENSION UNIT

The Vega MT-5 GNSS tracker allows you to connect the Vega BR-1 expansion unit via the RS-485 interface. Vega BR-1 has 15 multifunction inputs and 15 digital outputs.

To configure the inputs, you must connect to the device through the “Configurator” program, go to the “Settings” menu -> “Inputs/Outputs” tab and select the “Input/output extension unit”. Next, you need to select the connection interface - RS-485. After that, you can configure [multifunctional inputs](#) in accordance with the desired tasks.

To configure the outputs, it is necessary to connect to the device through the “Configurator” program, go to the “State” menu -> “Input/output expansion unit” tab. At the very bottom of the I/O list of the expansion unit are the digital output controls - the “On” and “Off” buttons.

ACTUATORS

Actuators are connected to the device via digital output which are of the type “Open collector”.

So, for example, you can connect a relay for blocking the engine/petrol pump/ignition, etc. After connecting the relay according to the scheme, you can send commands to the device to block or unblock the relay (see the section [“SMS commands”](#), command **setout**).

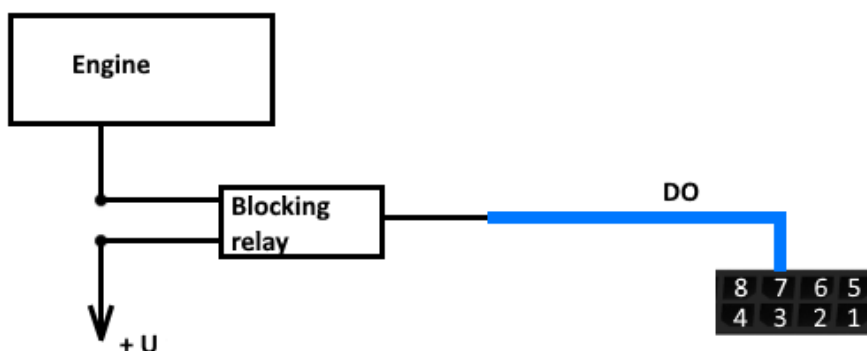

Permissible load on each digital output 0.5 A

To increase the load on the outputs of the device, you must use an external relay. The relay connection diagram is shown below.

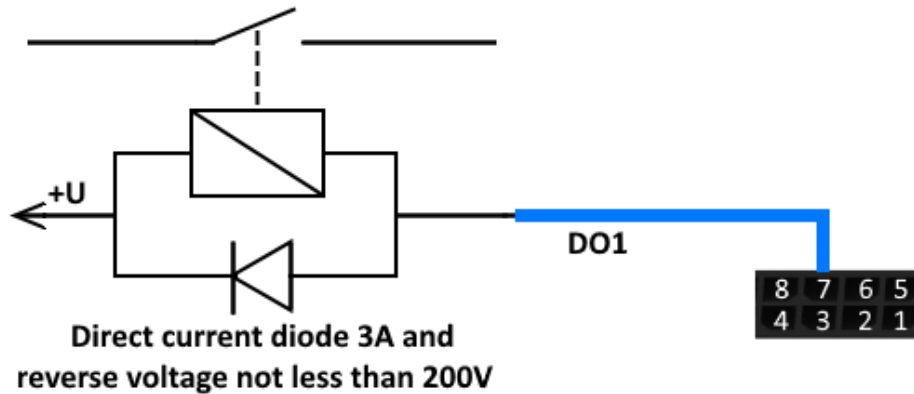

By default, after a device reboot, the state of the digital output is reset to 0, that is, "off". In the settings, it is possible to save the state of the device output and digital outputs of the connected [extension unit](#).

To do this, you need to connect to the device through the "Configurator" program, go to the "Settings" menu -> "Inputs/Outputs" tab and select the "Restoring output states after reboot". Opposite the desired output, select "restore" in the drop-down menu. Then, after a reboot, this digital output will be restored to the state that was written to the non-volatile memory of the device before the reboot.



Writing of statuses into non-volatile memory carried out at every 30 seconds

INPUTS

Vega MT-5 GNSS tracker has three multifunctional inputs that can operate in four modes:

- Analog;
- Digital;
- Frequency;
- Pulse.

In analog mode, the input voltage is measured. Such an input can be used for sensors whose readings vary in a certain range.

In digital mode, the input signal level (0 or 1) is measured. Such an input can be used for logic sensors, the readings of which are determined by two states (on/off).

In frequency mode, the frequency of the pulse signal is measured. Such an input, for example, is convenient to use for a car tachometer.

In pulse mode, the number of pulses at the input is counted. Such an input can be used for flow rate sensors, for example, fuel consumption.

In the settings of multifunctional inputs in the "Configurator" program, in addition to selecting a mode for each input, there is a parameter called "Active Level". It can take the value "low" and "high" and characterizes the magnitude and direction of the input tightening.

Input type	Low active level	High active level
Analog	Pull-down to the ground 240 kOhm	Pull-down to the ground 240 kOhm
Digital	Pull-up to external power 44 kOhm	Pull-down to the ground 240 kOhm
Pulse	Pull-up to external power 44 kOhm	Pull-down to the ground 240 kOhm
Frequency	Pull-up to external power 44 kOhm	Pull-down to the ground 240 kOhm



Pull-up to external power cannot be carried out while battery powered device

When the device is restarted, the multifunction input is pulled to the ground

BLE-SENSORS



Bluetooth does not work without a SIM card and whenever if the GSM modem is disconnected

Up to 5 sensors can be connected. For this it is necessary to connect to the device through the “Configurator” program and go to the «Settings» -> tab «Settings BT/BLE». There you can make Bluetooth scanning and create sensor from the list of discovered sensors because of scanning by context menu or button “Create BLE-sensor”.

Supported types of BLE-sensors.

- ⦿ BLE beacon – MAC binding tag;
- ⦿ Neomatika ADM31/ADM35 – sensor of temperature, humidity, ambient light level;
- ⦿ Neomatika ADM32 – angle sensor;
- ⦿ Escort TD-BLE – fuel level sensor;
- ⦿ Escort TT-BLE – temperature sensor;
- ⦿ Escort TL-BLE – sensor of temperature, ambient light level;
- ⦿ Escort DU-BLE – angle sensor;
- ⦿ Escort TH-BLE – sensor of temperature, humidity, ambient light level, pressure.

5 COMMUNICATION PROTOCOLS

The Vega MT-5 GNSS tracker supports several protocols: WIALON IPS, WIALON Combine, VEGA. The current protocol description is contained in a separate document, which can be found on the website fmsvega.ru.

6 MANAGING USING SMS-COMMANDS

Some settings of the Vega MT-5 GNSS tracker can be managed remotely via SMS commands. General command format is @PIN:command, where PIN is a four numbers PIN of the device (See "Security" part). There are also two information commands, in response to which an SMS message with information about the device settings.

Command	Format	Example
nosleep - not switch to the sleep mode	@PIN:nosleep	@5555:nosleep ----- PIN-код – 5555
reboot - device reboot	@PIN:reboot	@3333:reboot ----- PIN – 3333
tofactory - factory reset	@PIN:tofactory	@1234:tofactory ----- PIN – 1234
bboxclear – clear black box	@PIN:bboxclear	@1234:bboxclear ----- PIN– 1234
setout – set the output state	@PIN:setoutY=Z ----- Y – output number Z – state (0 or 1)	@4321:setout2=1 ----- PIN– 4321 Output number – 2 State – 1
setextout – set the output state of extension unit	@PIN:setextoutY=Z ----- Y – output number of extension unit Z – state (0 or 1)	@4444:setextout8=0 ----- PIN- 4444 Output number of extension unit – 8 State – 0

<p>server - set the server address</p>	<p>@PIN:serverY:addr:port&protocol&period&terminal_addr</p> <p>----- Y – server number addr – server address port – server port protocol – protocol type: off vega – engineering server egts – EGTS server egts_l1 – EGTS Light 1 egts_l2 – EGTS Light 2 wcombine – Wialon Combine server wips – Wialon IPS server ndtp – NDTP server</p> <p>period – communication period with server terminal_addr – device address for NDTP or device ID for EGTS protocol</p>	<p>@2222:server3:193.193.165.165:20332&wips&0&90008</p> <p>----- PIN – 2222 Server number – 3 Server address – 193.193.165.165 Server port – 20332 Exchange protocol – Wialon IPS Communication period – 0 (constantly in touch) NDTP address or EGTS device ID – 90008</p>
<p>setapn - set APN</p>	<p>@PIN:setapn:apn&user&pass</p> <p>----- apn – APN user – username pass – password</p>	<p>@1234:setapn:internet.beeline.ru&beeline&beeline</p> <p>----- PIN – 1234 APN – internet.beeline.ru Username – beeline Password – beeline</p>
<p>info? - current device state request</p>	<p>@PIN:info?</p>	<p>@1234:info?</p> <p>----- PIN – 1234</p>
<p>server? - request monitoring server settings</p>	<p>@PIN:server?</p>	<p>@4444:server?</p> <p>----- PIN – 4444</p>
<p>runcanscript – run CAN script number X</p>	<p>@PIN:runcanscriptX</p> <p>X – CAN number that is needed to run</p>	<p>@4444:runcanscript3</p> <p>----- PIN – 4444 CAN script number 3</p>

t:unixtime – set lifetime for the command	@PIN:XXXX/t:unixtime XXXX – command for which is needed to set a lifetime unixtime – time in UTC when the command will not execute even the SMS with it just comes. For example, we send the command for device rebooting at the 14.00 and set lifetime for that command until 14.10. So if the device receives the command from 14.00 to 14.10 the command will execute as usual, but if the SMS will delayed, will not be delivered immediately etc., and the device receives the command at the 14.15 the command will not execute because lifetime is up. After the time has passed, the message "Execution time has expired" will come	@4444: reboot/t: 1577196600 ----- PIN – 4444 Command – device reboot Lifetime of the command is until 14:10:00 24.12.2019
changesim – change current SIM	@PIN:changesim	@4444:changesim ----- PIN – 4444
changesim1 – change SIM to the first	@PIN:changesim1	@4444:changesim1 ----- PIN – 4444
changesim2 – change SIM to the second	@PIN:changesim2 Answer examples: <i>changesim:2 ok</i> – command successfully done; <i>changesim:2 err, already in use</i> – SIM2 already used.	@4444:changesim2 ----- PIN – 4444

When requesting the current state of the block, a message arrives with the following contents:

Vega MT-5 CAN v3.10 0.4b – device name and firmware version

imei: 355217043382910 – device IMEI number

lat: 55.1173, lon: 37,9475, - device coordinates (latitude and longitude)

sat inview: 22, - number of visible satellites

sat inuse: 14, - number of satellites used

valid: 1 – validity of certain coordinates (0 – no, 1 – yes)

ign: 0, - ignition (0 – no, 1 – yes)

acc: 4.1, ext: 12.1, - built-in battery and vehicle voltage

temp: 19,5, - environment temperature

move: 0 – moving (0 – no, 1 – yes)

black box: 0, 4, 0, 0 – the number of messages in black boxes in order in the 1st, 2nd, 3rd and 4th.

When you request monitoring server settings, a message appears with the following contents:

server1:

193.193.165.144:20333&wips&0&0

server2:

46.183.183.4:16122&egts&15&43382912

server3:

193.193.154.154:20453&off&0&0

server4:

37.194.197.213:5604&vega&0&0

Here in order are indicated - server address: port & protocol (if enabled) or off (if data exchange with this server is turned off) & communication period in minutes & device address for NDTP or device ID for EGTS protocol.



If you enter an incorrect PIN, the device does not respond to the sender

7 STORAGE AND TRANSPORTATION REQUIREMENTS

Vega MT-5 devices shall be stored in the original packaging in heated room at temperatures +5 °C to +40 °C and relative humidity less than 85%.

The device shall be transported in covered freight compartments of all types at any distance at temperatures -40 °C to +85 °C. After transporting the devices at low temperatures, it is recommended to hold them at room temperature for 24 hours before starting operation.

8 CONTENT OF THE PACKAGE

GNSS tracker Vega MT-5 – 1 pc.

Wire connector – 1 pc.

Factory certificate – 1 pc.

9 WARRANTY

The manufacturer guarantees that the product complies with the current technical documentation, subject to the storage, transportation and operation conditions specified in the "User Manual".

The warranty period is 36 months.

The warranty for the battery is provided separately and is 3 months.

The warranty period of operation is calculated from the date of sale marked in the product factory certificate, and from the release date when such a mark is absent. During the warranty period, the manufacturer is obliged to provide repair services or replace a failed device or its components.

The manufacturer does not bear warranty obligations in the event of a product failure if:

- the product does not have a factory certificate;
- the factory certificate does not have an TCD stamp and / or there is no sticker with information about the device;
- the serial number (DevEUI, EMEI) printed on the product differs from the serial number (DevEUI, EMEI) specified in the factory certificate;
- the product has been subject to alterations in the design and / or software which are not provided for in the operational documentation;
- the product has mechanical, electrical and / or other damage and defects arising from violation of the conditions of transportation, storage and operation;
- the product has traces of repair outside the manufacturer's service center;
- the components of the product have internal damage caused by the ingress of foreign objects / liquids and / or natural disasters (flood, fire, etc.).

In the event of a warranty claim, contact the service center:

119A Bol'shevistskaya str., Novosibirsk, 630009, Russia.

Tel +7(383) 206-41-35.

e-mail: remont@vega-absolute.ru

Document Information	
Title	GNSS tracker Vega MT-5
Document Type	Manual - Translation from Russian
Document Number	B01-MT5-01
Revision and date	05 of 17 October 2022

Revision History

Revision	Data	Name	Comments
01	02.09.2021	KEV	Document release date
02	30.09.2021	KMA	Correction of typos
03	16.03.2022	KMA	New sticker
04	01.07.2022	KEV	Correction of the part " Mounting Recommendations ", we add item 2 to step by step mounting
05	17.10.2022	KEV	Changes in warranty conditions



vega-absolute.ru

User Manual © ООО Vega-Absolute 2020-2022